

Data sheet

Commercial Art.No.: 0D.S07.3527.0

insert bridge IVB WTN 6-5 IN

insert bridge IVB WTN 6-5 IN modular spacing 8 mm, insulated yes, number of poles 5, color grey, height 24.2 mm, mounting method screwable, inflammability class of insulation material acc. with ul94 V0

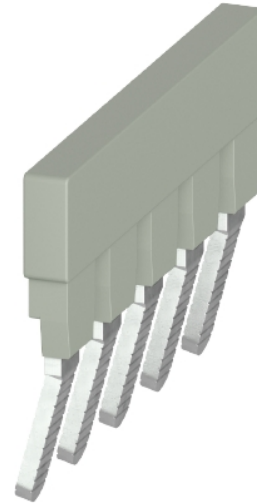

Commercial Art.No.	0D.S07.3527.0
EAN	4049088723476
Order Unit	100

Technical data

general

color	grey
inflammability class of insulation material acc. with UL94	V0
width/grid dimension	38.5 mm
length	3.2 mm
modular spacing	8 mm
number of bridged clamps	5
mounting method	screwable
insulated	yes
model	cross connector
height	24.2 mm

classification

ETIM 9.0	EC000489
----------	----------

product compliance

REACH-SVHC conformity status	compliant
------------------------------	-----------

Alle Rechte vorbehalten
 All rights reserved
 Vertraulich
 Confidential

These dimensions will be especially checked at delivery
 Only inspection dimensions
 With /E marked dimensions are only valid for internal use

Diese Maße werden bei Abnahme besonders geprüft
 Ausschließlich Prüfmaße
 Mit /E gekennzeichnete Maße sind nur für interne Zwecke gültig

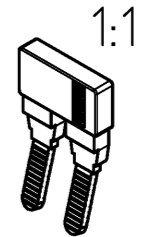
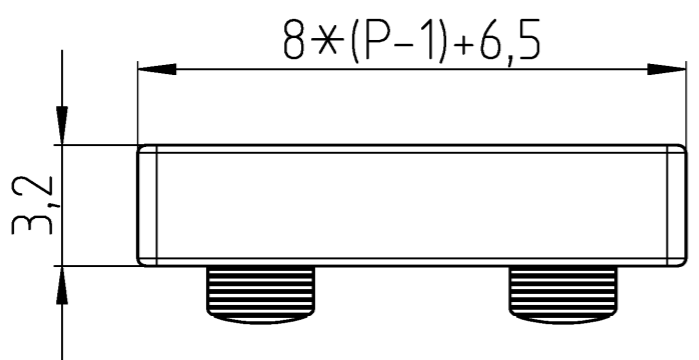
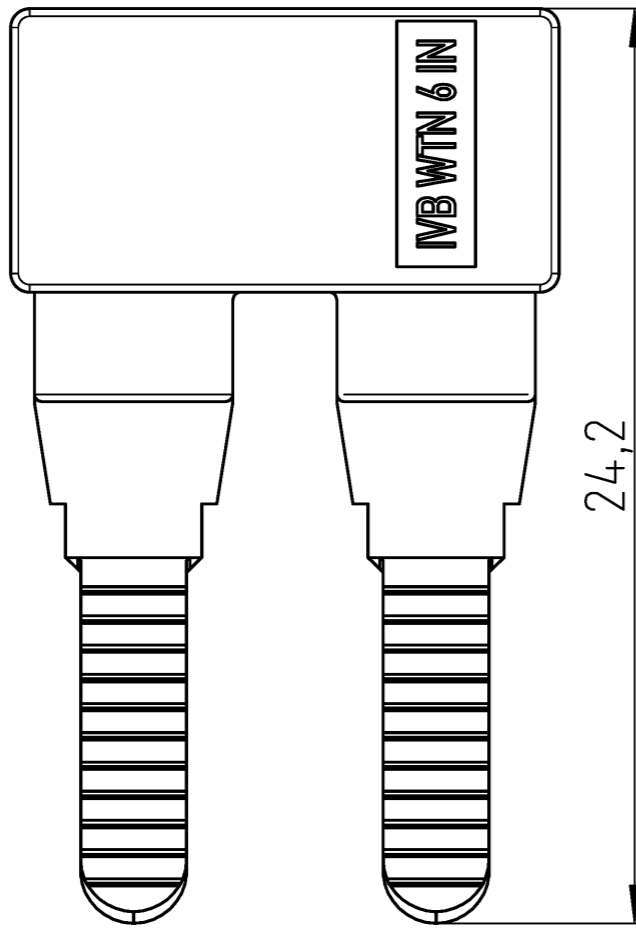

Weitere Daten siehe KATALOG oder eKatalog
 additional data see CATALOG or eCATALOG
www.wieland-electric.com
eshop.wieland-electric.com

Tolerierung Size ISO 14405 ☺ / Tolerance system Size ISO 14405 ☺.
 (This ISO-standard describes the envelope principle. According to the envelope principle the deviations of form and parallelism are limited by the size tolerances).
 ja/yes Stoffverbots- und Deklarationsliste nach WN 5020.010 ist einzuhalten.
 Conformity with Wieland document WN 5020.010 e (list of prohibited / declarable hazardous substances) to be declared!

Freitoleranz nach General tolerance CAD - Zeichnung, keine manuellen Änderungen CAD - drawing, no manual modifications allowed 1. Verwendung: First Use: Blatt: 1 von 1 Sheet: 1 of 1

Bestell-Nr. /order no.	Polzahl P /number of poles P	Typ /type	Farbe /colour	VPE: packaging unit:
0D.S07.3227.0	2	IVB WTN 6-2 IN	grau / grey	200
0D.S07.3327.0	3	IVB WTN 6-3 IN	grau / grey	
0D.S07.3427.0	4	IVB WTN 6-4 IN	grau / grey	
0D.S07.3527.0	5	IVB WTN 6-5 IN	grau / grey	100
0D.S07.4027.0	10	IVB WTN 6-10 IN	grau / grey	

Werkstoff / Material	Tag/Date	Name	Zeichnung Nr. / Drawing No. T 0D.S07.3227.0 13K	Index
Maßstab / Scale 5:1	gezeichnet drawn 14.10.2025	Eichhorn N.		
Elektronische Freigabe Electronic Release			Maße in mm / Dimensions are in mm	
Ersatz für / Replacement for:			Type	
			Benennung/Title EINLEGEBRUECKE connection plug	
Index	Datum / Blatt Date / Sheet	Änderung / Revision		